

# DIGITAL PRESENTER (ELMO)

## VIDEO CONFERENCING

The Digital Presenter replaces the traditional overhead units. It can display transparencies, documentation and 3D objects.

\*Located in all Instructing DDI Classrooms



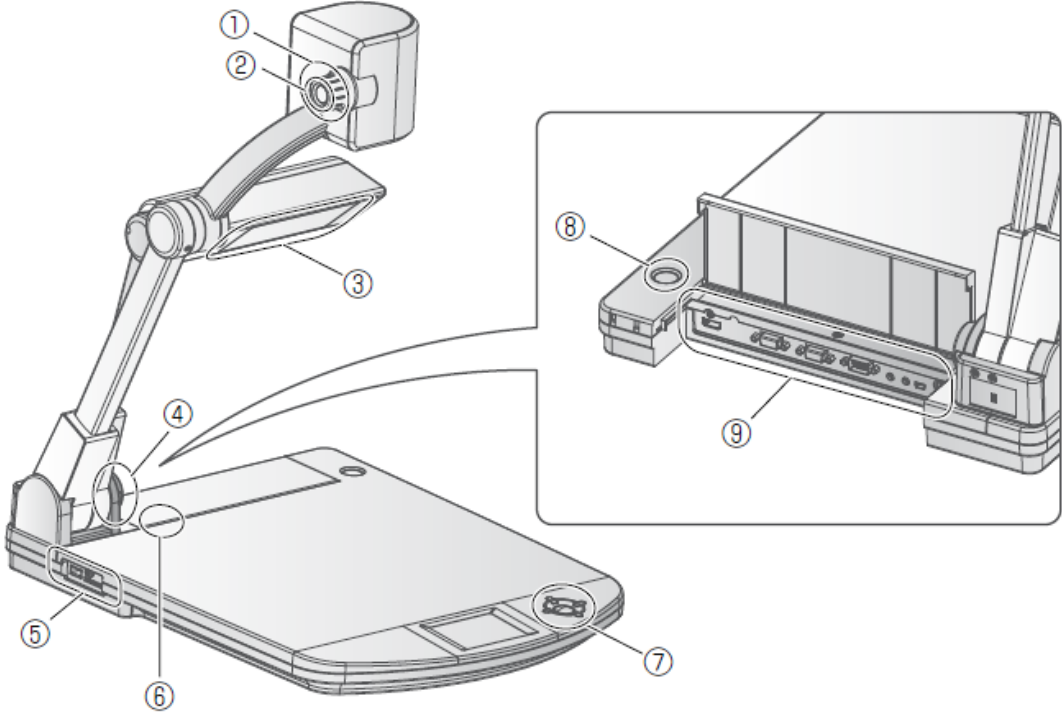



## PART NAMES

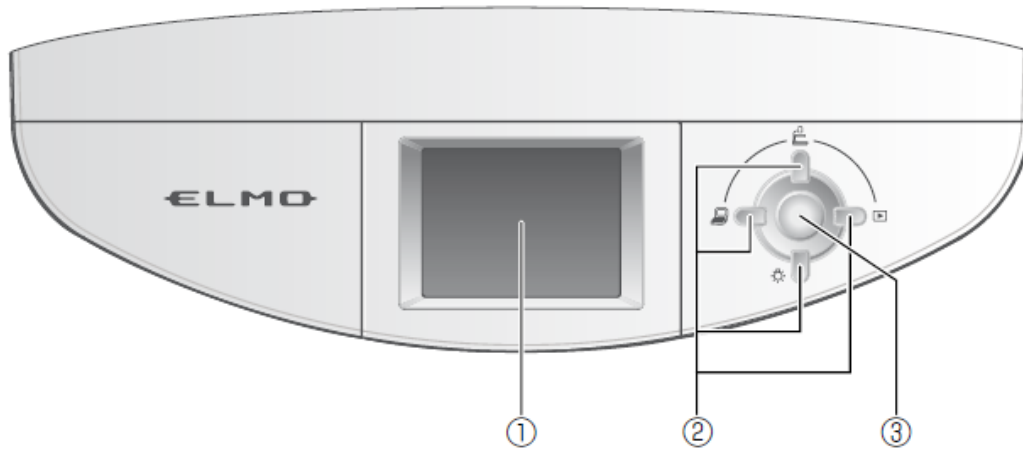







No	Name
①	Zoom dial
②	AF button
③	Illumination
④	Remote control sensor
⑤	Side panel
⑥	Built-in mic
⑦	Operating panel
⑧	Main switch
⑨	Rear panel

## OPERATING PANEL





	Mark		Function
①	LCD panel		To display the output video and the OSD.
②	Not displayed in the OSD.	 (up) button	To switch the screen to camera image. The color of the front operating panel LED changes to blue.
		 (down) button	To turn ON/OFF the lamp.
		 (right) button	To switch the output image to images stored on the SD card. The color of the front operating panel LED changes to orange. <b>Not Used</b>
		 (left) button	To switch the output image to the image input to RGB IN. The color of the front operating panel LED changes to pink. <b>Not Used</b>
	OSD Menu	 (up, down, left, right) button	To be used for selecting the menu item.
③		MENU/ENTER button	To show the OSD or select the menu item.

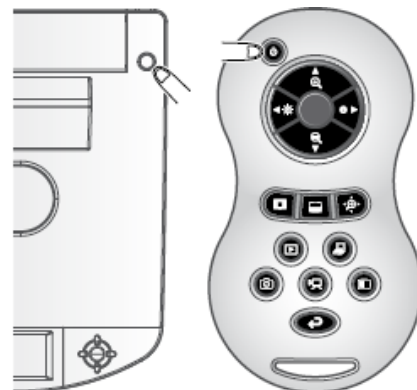

## TURNING THE POWER ON AND OFF

- Press the [  ] on the operating panel or the [  ] button on the remote control to turn the power ON.  
(After the [  ] Button flashes blue, it is illuminated a few seconds later.)
- Hold down the [  ] button on the operating panel or the [  ] button on the remote control for two seconds or more to turn the power OFF.  
(The [  ] button is illuminated in red.)



## ADJUSTING THE SIZE

The display range of the document can be adjusted by rotating the zoom dial on the main unit or by pressing the [  /  ] buttons on the remote control.

- ZOOM-IN  : The object can be shown in large size.
- ZOOM-OUT  : The object can be shown in small size.

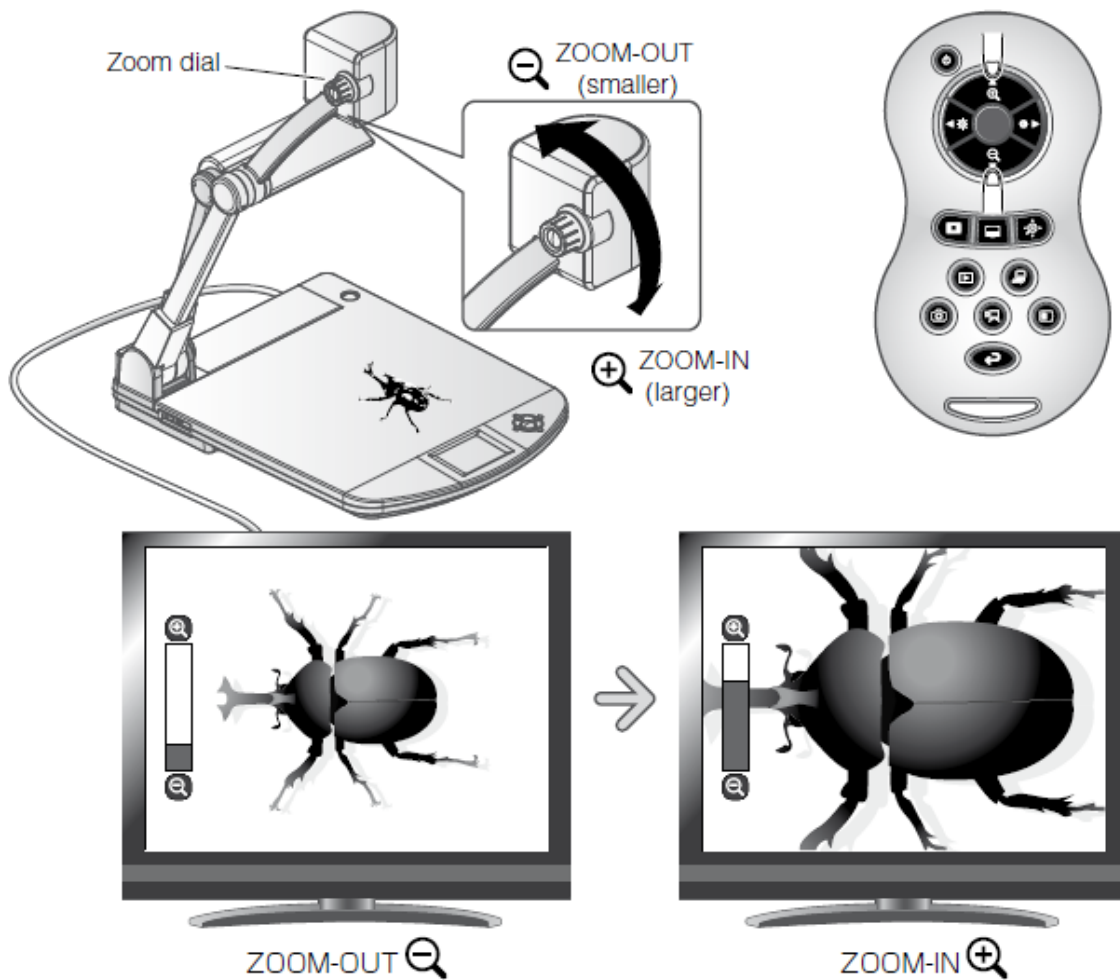

Contact IT Services if you would like training on the equipment.

\*Please refrain from using permanent markers that bleed through paper on the Elmo